



China patent No.:

ZL02220153.X,

ZL200720045551.5

Multi-functional Flow Control Valve for Water Treatment Systems

51240B (F112BS)

53540B (F112B1)

53640B (F112B3)

61240B (F112AS)

63540B (F112A1)

63640B (F112A3)



User Manual

Please read this manual in details before using the valve and
keep it properly in order to consult in the future.

0WRX.466.612

Before the valve put into use, please fill in the below content so as to help us to refer in the future.

The Program Type Setting (Operation by professional)

When all symbols light on, press and hold  and  buttons for 5 seconds to enter the menu of valve model selection. **Please set the program type in accordance with the product type.**

Softener System Configuration

Tank Size: Dia. _____ mm, Height _____ mm;
 Resin Volume _____ L; Brine Tank Capacity _____ L;
 Hardness of Raw water _____ mmol/L;
 Pressure of Inlet Water _____ MPa;
 Control Valve Model _____ ; Number _____ ;
 The Specification of Drain Line Flow Control _____ ;
 Injector No. _____ .
 Water Source: Ground-water Filtered Ground-water
 Tap Water Other _____ .

Parameter Set

Parameter	Unit	Factory Default	Actual Value
Time of Day	h:m	Random	
Control Mode A-01/02(63640B/53640B)	/	A-01	
Water Treatment Capacity (63640B/53640B)	m ³	400.0	
Operation Days (63540B/53540B)	D.	03	
Regeneration Time	/	02 : 00	
Backwash Time	min.:sec.	10:00	
Brine Draw Time	min.:sec.	60:00	

(63540B/63640B)			
Slow Rinse Time (63540B/63640B)	min.:sec.	45:00	
Brine Refill Time (63540B/63640B)	min.:sec.	05:00	
Fast Rinse Time	min.:sec.	10:00	
Interval Regeneration Days (63640B/53640B)	D.	30	
Output Mode b-01(02)	/	b-01	
K Value (Only for Meter Type)	/	4.194	

● If there is no special requirement when product purchase, we choose 4# drain line flow control (with six pieces of $\phi 8$ holes) and 4# injector (7804) for the standard configuration for 63540B, 63640B and 61240B.

Catalogue

Notice	
1.Product Overview	
1.1.Main Application & Applicability.....	
1.2.Product Characteristics	
1.3.Service Condition	
1.4.Product Structure and Technical Parameters	
1.5. Installation	
2. Basic Setting & Usage	
2.1.The Function of PC Board	
2.2.Basic Setting & Usage	
2.3. Usage of Manual Wheel.....	
2.4. Meanings of Figures on Decorative Cover	
3.Applications	
3.1. Flow Chart.....	
3.2.The Function and Connection of PC Board.....	
A. Signal Output Connector	
B. Interlock	
C. Pressure Relief Output	
D. Remote Handling Connector	
E. Interlock System	
F. Series System	
3.3.System Configuration and Flow Rate Curve.....	
3.4.Parameter Settlement	
3.5.Parameter Enquiry and Setting.....	
3.6.Trial Running	
3.7.Trouble-Shooting.....	
3.8.Assembly & Parts.....	
4.Warranty Card	

Notice

- To ensure normal operation of the valve, please consult with professional installation or repairing personnel before use it.
- If there are any of pipeline engineering and electric works, there must be finished by professional at the time of installation.
- Do not use the control valve with the water that is unsafe or unknown quality.
- Depending on the changing of working environment and water requirement, each parameter of softener should be adjusted accordingly.
- When the water treatment capacity is too low, please check the resin. If the reason is shortage of resin, please add; if the resin is turn to reddish brown or broken, please replace.
- Test water periodically to verify that system is performing satisfactorily.
- Ensure that there is solid salt all the time in the brine tank in the course of using, when this valve is used for softening. The brine tank should be added the clean water softening salts only, at least 99.5% pure, forbidding use the small salt.
- Do not put the valve near the hot resource, high humidity, corrosive, intense magnetic field or intense vibrations environment. And do not leave it outside.
- Forbidden to carry the injector body. Avoid using injector body as support to carry the system.
- Forbidden to use the brine tube or other connectors as support to carry the system.
- Please use this product under the water temperature between 5~50°C, water pressure 0.2~0.6MPa. Failure to use this product under such conditions voids the warranty.
- If the water pressure exceeds 0.6Mpa, a pressure reducing valve must

be installed before the water inlet. While, if the water pressure under 0.2MPa, a diaphragm pump must be installed before the water inlet.

- It is suggested to install PPR pipe, corrugated pipe or UPVC pipe, instead of TTLSG pipe.
- Do not let children touch or play, because carelessness operating may cause the procedure changed.
- When the attached cables of this product and transformer are changed, they must be changed to the one that is from our factory.

1. Product Overview

1.1. Main Application & Applicability

Used for softening, demineralization or filtration water treatment systems

51240B/53540B/53640B (Filter)

Suit for swimming pool filter equipment

Filtration equipment

RO pretreatment active carbon and sand filtration system

61240B/63540B/63640B (Down-flow softener regeneration)

Suit for the ion exchange equipment which hardness of the raw water $\leq 6.5\text{mmol/L}$

Boiler softening water system

RO pretreatment softening system

1.2. Product Characteristics

➤ **Simple structure and reliable sealing**

The distribution valve adopts hermetic head faces with high degree pottery and corrosion resistance for opening and closing. It combines with Service, Backwash, Brine Draw, Slow Rinse, Fast Rinse and Brine Refill.

➤ **No water passes the valve during regeneration in single tank type.**

➤ **Brine refilling is controlled by electric ball valve.**

Brine refilling is controlled by electric ball valve, refilled when in service, shorten the regeneration time.

Brine refilling and service are operating in the meanwhile, for fixed bed, the water for brine refilling is hard water.

➤ **Fixed bed regeneration softener could be converted to filter system.**

Blocking the brine line connector of 61240B/63540B/63640B, removing the drain connector, the valve could be converted to filter system.

➤ **Manual function**

Realize regeneration immediately by pushing “” at any time.



➤ **Long outage indicator**

If outage overrides 3 days, the time of day indicator “12:12” will flash to remind people to reset new time of day. The other parameters do not need to be reset. The process will continue to work after powering on.





➤ **LED dynamic screen display**

The stripe on dynamic screen flashes, which indicates the control valve is in service, otherwise, it is in regeneration cycle.

➤ **Buttons lock**

No operations to buttons on the controller within 1 minute, button lock indicator lights on which represents buttons are locked. Before operation press and hold the “” and “” buttons for 5 seconds to unlock. This function can avoid incorrect operation.

➤ **It can choose time clock type or meter type by program selection**

When all symbols light on, press and hold “” and “” buttons more than 2 seconds to enter the menu of valve model selection. Press “” or “” buttons to select the requested model, then press “” button to save the selection. Reconnect the power, the model will be showed on display board.

➤ **Interlock function**

It has a function of interlock to realize only one valve in regeneration but the other valves are in service while several valves parallel in system. In multi-steps treatment systems such as RO pre-treatment, when several valves are in series, there is only one valve in regeneration or washing to ensure pass water all the times while different valves in regeneration or washing.(Application refers to Figure 3-9)

➤ **Control signal output**

There is a signal output connector on main control board. It is for controlling external wiring (Refer to figures from Figure3-1 to Figure 3-8).

There are two kinds of output modes: b-01 Mode: Turn on at the start of regeneration and shut off at the end of regeneration; b-02 Mode: Signal is available only at intervals of regeneration cycles and in service.

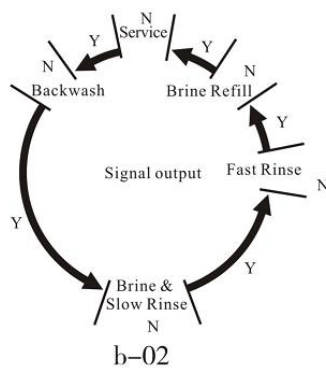
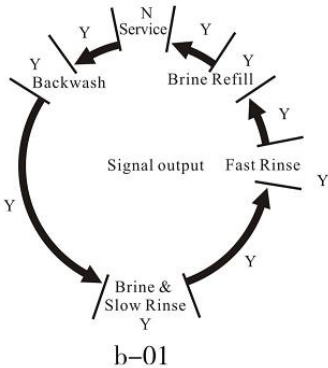

➤ **Remote handling input**

This connector can receive external signal, used together with PLC, and computer etc. to control the valve. (Application refers to Figure3-11)

➤ **Pressure relief output**

The valve will cut off feeding water to drain line when it switches in regeneration cycles (Same as signal output b-02). Thus in some water treatment system, e.g. deep well, one diaphragm booster pump was

installed on the inlet to increase the system water feeding pressure, this cut-off will cause pressure on inlet rising too fast to damage the valve. Pressure relief output can be used to avoid this problem. (Application refers to Figure3-10)

➤ **All parameters can be modified**

According to the water quality and usage, the parameters in the process can be adjusted.

➤ **Two meter types for option (Suit for 63640B/53640B)**

Mode	Name	Instruction
A-01	Meter Delayed	Regenerate on the day although the available volume of treated water drops to zero (0). Regeneration starts at the regeneration time.
A-02	Meter Immediate	Regenerate immediately when the available volume of treated water drops to zero (0).

➤ **Maximum interval regeneration days (Suit for 53640B/63640B)**

Under the situation of service reaching the setting days and the volume not yet, it could enter into regeneration process forcibly when current time is the same as regeneration time.

1.3. Service Condition

This valve should be used under the below condition

Item		Requirement
Working conditions	Water pressure	0.2MPa~0.6MPa
	Water temperature	5°C~50°C
Working environment	Environment temperature	5°C~50°C
	Relative humidity	≤95% (25°C)
	Electrical facility	AC100~240V/50~60Hz

Inlet water quality	Water turbidity	Down-flow regeneration (61240B/63540B/63640B)<5FTU Filter (51240B/53540B/53640)<20FTU
	Water hardness	First Grade Na ⁺ <6.5mmol/L; Second Grade Na ⁺ <10mmol/L
	Free chlorine	<0.1mg/L
	Iron ²⁺	<0.3mg/L
	CODMn	<2mg/L (O ₂)

In the above table, First Grade Na⁺ represents First Grade Na⁺ Exchanger. Second Grade Na⁺ represents Second Grade Na⁺ Exchanger.

- When the water turbidity exceeds the conditions, a filter should be installed on the inlet of control valve.
- When the water hardness exceeds the conditions, the outlet water hardness will hardly reach the requirement of boiler feed water (0.03 mmol/L). It is suggested to adopt second grade softener.

1.4. Product Structure and Technical Parameters

A. The appearance is just for reference. It is subjected to the real product.

Model	A (mm) max	B (mm) max	H (mm) max
53540B/F112B1	562	685	580
63540B/F112A1	562	685	746
51240B/F112BS	562	620	580
61240B/F112AS	562	620	746

Remark: If 53540B/F112B1 and 63540B/F112A1 are installed a flow meter on outlet, and then they will be the structure of 53640B/F112B3 and 63640B/F112A3.

53540B (F112B1):

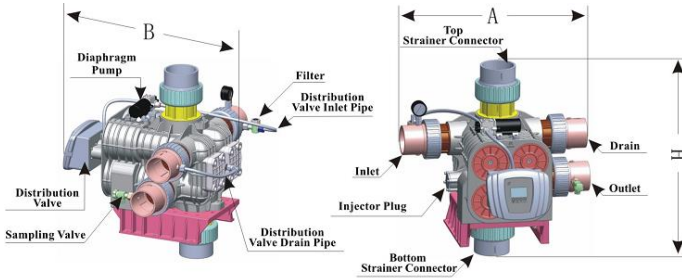

63540B (F112A1):

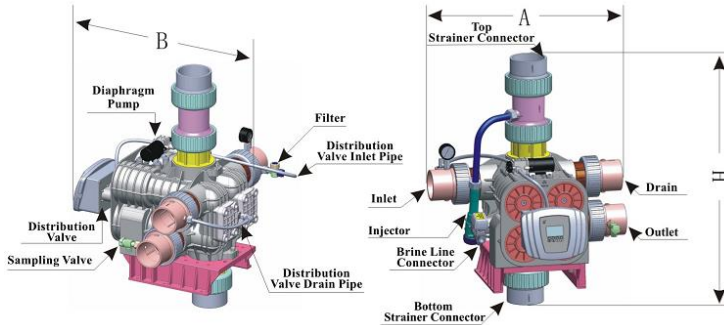

51240B (F112BS):

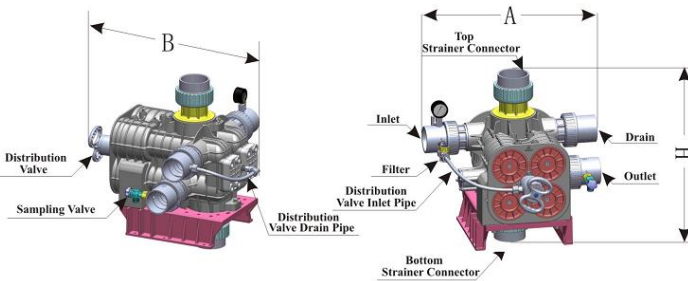

61240B (F112AS):

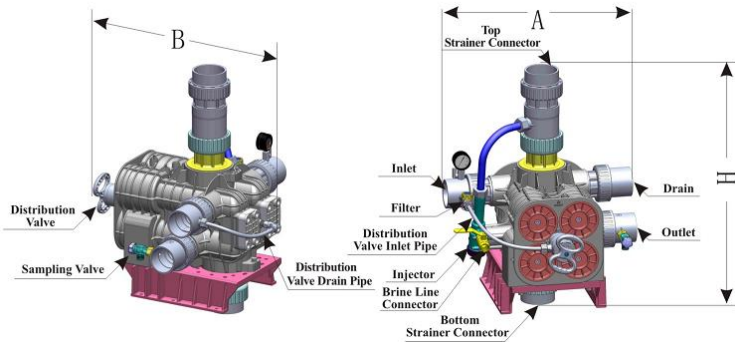

B. Technical parameter

The suitable output of transformer for control valve: DC24V, 4.0A

Model	Connect Size					Flow Rate m ³ /h @0.2MPa	Regeneration Mode	Remark
	Inlet/Outlet	Drain	Brine Line Connector	Regeneration Connector	Top and Bottom Strainer			
51240B	DN65	DN65	/	/	DN80	Please see P29 Flow Rate Characteristic	Manual	Filter
53540B							By days	
53640B							By meter	
61240B	DN65	DN65	3/4" M	/	DN80	40	Manual	Down-flow w regeneration
63540B							By days	
63640B							By meter	

Note: M-Male F-Female

DN65—Outer diameter is φ75 UPVC pipeline.

DN80—Outer diameter is φ90 UPVC pipeline.

1.5. Installation

A. Installation notice

Before installation, read all those instructions completely. Then obtain all materials and tools needed for installation.

The installation of product, pipes and circuits, should be accomplished by professional to ensure the product can operate normally.

Perform installation according to the relative pipeline regulations and the specification of Water Inlet, Water Outlet, Drain, and Brine Line Connector.

B. Device location

- ① The filter or softener should be located close to drain.
- ② Ensure the unit is installed in enough space for operating and maintenance.
- ③ Brine tank need to be close to softener.
- ④ The unit should be kept away the heater, and not be exposed outdoor. Sunshine or rain will cause the system damage.
- ⑤ Please avoid to install the system in one Acid/Alkaline, Magnetic or strong vibration circumstance, because above factors will cause the system disorder.
- ⑥ Do not install the filter or softener, drain pipeline in circumstance which temperature may drop below 5°C, or above 45°C.
- ⑦ One place is recommended to install the system which causes the minimum loss in case of water leaking.

C. Support installation

Take out 8 pieces of support and door mats, and install them according to the Figure 1-1. (The parts description please refers to 5040009 support structure on page 50.)

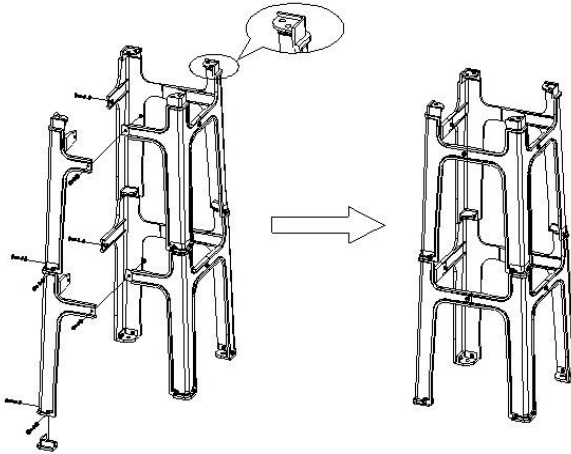

Figure 1-1

D. Pipeline installation, take 63640B (F112A3) as example

① Install control valve

- a. As the Figure 1-2 shows, insert the riser pipe to the bottom strainer and put it into the bottom of the tank.
- b. Fill the mineral to the tank, and the height is accordance with the design code. Assemble the top strainer.
- c. Connect the control valve and support with screw.
- d. Choose the suitable position to install the valve. Using DN80 (Outer diameter is $\phi 90$) UPVC pipe to connect top and bottom strainer connectors with tank's top and bottom strainers.



Figure 1-2

Notice:

- Avoid filling floccules substance together with resin to the mineral tank.
- Pipe installation should be straight, and shall not make control valves or the fittings by torsion.

② Install flow meter and the inlet/outlet pipeline

A. Install flow meter

Safe notice:

A. Before installation, make sure there is no pressure in pipeline and check if pressure released completely.

B. Before installation, make sure the tested liquid won't make corrosion for the probe. (The testing subject of the probe is water)

C. Before installation, make sure the temperature and pressure is comply with the probe's requirement. (The temperature of the liquid: 5~50°C; Testing pressure: ≤ 0.6 MPa)

D. Before installation, make sure the flow rate of the liquid won't exceed the probe's range. (Testing range: 1~5m/s) .

E. Before installation, don't change the probe's shape structure and testing way.

F. Probe wiring couldn't connect with the transformer which has strong electric or voltage bigger than 12V. Otherwise, it will burn the electric board.

Probe test position choosing:

A. The measure distance of tangential path behind flange should comply with 10 times front and 5 times back of pipeline diameter.

B. The measure distance of tangential path behind reducer (Only allow turn big to small, but not in reverse) should comply with 15 times front and 5 times back of pipeline diameter.

C. The measure distance of tangential path behind first class equal elbow should comply with 20 times front and 5 back of pipeline diameter.

D. The measure distance of tangential path behind coplanar second class continuous equal elbow should comply with 25 times front and 5 times back of pipeline diameter.

E. The measure distance of tangential path behind non-coplanar second class continuous equal elbow should comply with 40 times front

and 5 times back of pipeline diameter.

F. The measure distance of tangential path behind valve should comply with 50times front and 5 times back of pipe diameter.

G. Suggest that install probe perpendicularly by pipeline, shouldn't be installed in the bottom of pipeline.

H. Probe can be installed in perpendicular pipeline which is upward flow direction, but also shall meet the above line requirement.

I. Probe can not be installed in perpendicular pipeline which is downward flow direction.

J. The water in tested pipeline should be full. Make sure no air in the pipeline.

Repair and maintenance of flow meter:

A. Before the installation of probe need confirm the impeller in free rotating, there is no obvious block phenomenon.

B. When the flow meter stops measuring but the tested liquid still flow, it can check the work mode of probe online. Screw the probe nut A out, and check the working condition of the diode on the back of probe. If the diode always light on or off, it indicates the impeller in pipeline stop rotating. It shall stop pipeline working, release pressure in pipeline, and disassemble the probe to check if there is any foreign matter impact impeller rotating. After cleaning, if it can rotate normally by manually, and the diode works normally, it can continue to use after confirming the installation correct.(As Figure 1-3)

C. If the probe has impeller broken, the top bracket of probe damaged, bearing bended, after repairing but still unable to free rotation or the wetted part has corrosion, or the installation screw thread serious damaged, it shall replace a new probe.

D. If the diode on the back of probe works normally, but the display board shows incorrect, please check if the probe wire has any damage and use a multi-meter to check the voltage between shielding and black wire if normally. If the diode light on, there is no voltage output; and if the diode light off, there is voltage output.

E. As the staining in liquid may cause impeller rotation not smooth, it may affect the measurement accuracy of probe. Therefore, it shall inspect and clean the impeller of probe periodically.

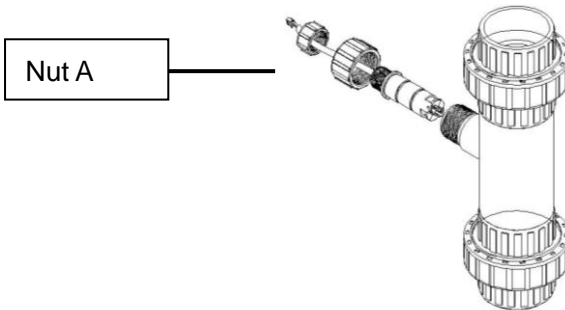

Figure1-3

b. As Figure 1-2, install a disc filter on the inlet of the filter.

c. Install valve A, valve B and valve C on the inlet, outlet and the middle of the pipeline of inlet and outlet.

d. Glue the inlet of the system with the inlet of the valve with DN65 UPVC pipeline (The outer diameter is $\phi 75$); Glue the flow meter with outlet of the valve with DN65 UPVC pipeline (The outer diameter is $\phi 75$); Glue the outlet of the system with flow meter with DN65 UPVC pipeline (The outer diameter is $\phi 75$).

e. Disassemble the front cover of the valve, and connect the flow meter to the flow meter connector of the main control board. (Refer **P22** main control board figure)

Notice:

- If making a soldered copper installation, do all sweat soldering before connecting pipes to the valve. Torch heat will damage plastic parts.
- When turning threaded pipe fittings onto plastic fitting, use care not to cross thread or broken valve.
- Inlet pipeline should be in parallel with outlet pipeline. Support inlet and outlet pipeline with fixed holder.
- If the valve belongs to time clock type, there is no flow meter installation

step.

③ Install drain pipeline (If no special request, the injector is 7804)

a. According to P28, for 63540B and 63640B, if the diameter of the tank is 1500mm, please do as step e; if the diameter of the tank is 1200mm, please do as following steps:

b. According to P30, match the drain line flow control based on the number and size of the hole.

c. Use the white manual handle as Figure 1-4 shows to open the drain connector, take out the drain line flow control, change it to the suitable one. (Please refer the hole of P30)

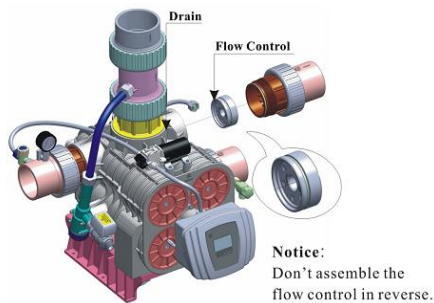

Figure 1-4

d. Tight the drain connector with the drain of the valve.

e. Use DN65 (Outer diameter is $\phi 75$) UPVC pipeline stick to the drain, drain pipeline should directly to the sewer, the sewer and the drain pipeline should installed as Figure 1-5.

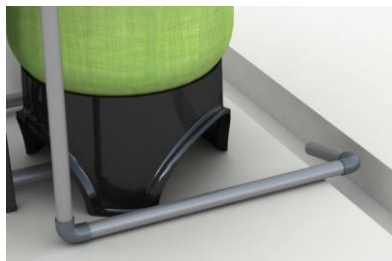

Figure 1-5

f. For 51240B (F112BS), 53540B (F112B1) and 53640B (F112B3) filter valve, there is no drain line flow control, please do as step e.

Notice:

- Leave a certain space between the drain pipe and the sewer, avoid wastewater being absorbed to the water treatment equipment.
- The drain pipeline shouldn't be too long, and the drain shouldn't be higher than the valve. For softener, drain pipeline should not be longer than 5m; for filter, it should not be longer than 2m. If the drain pipeline is longer or higher than the requirement, please disassemble the connector between distribution valve and drain and let the drain of distribution valve connect with the air. Use G1/2 female screw to block the G1/2 male of drain. Please refer the Figure 1-6.



Figure 1-6

④ Connect brine tube

a. As Figure 1-2 shows, use DN20 UPVC pipeline and other pipeline to connect the brine valve and the brine line connector of the valve.

Notice

- The brine pipeline should be as shorter as possible, and smooth. There are less four elbows in the pipeline, or it will make the brine sucking unsmooth.
- It must install brine valve in the brine tank.

2. Basic Setting & Usage

2.1. The Function of PC Board

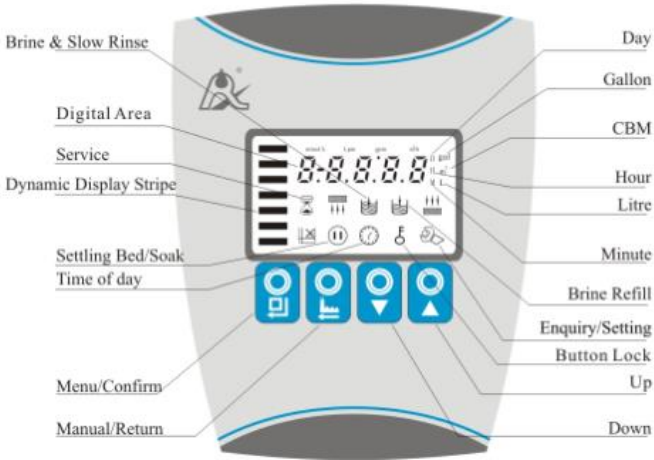

A. “🕒” Time of day indicator

“🕒” Lights on, display the time of day.

B. 🔒 Button lock indicator

● 🔒 Lights on, indicate the buttons are locked. At this moment, press any single button will not work (No operation in one minute, 🔒 will light on and lock the buttons.)

● Solution: Press and hold both ▲ and ▼ for 5 seconds until the 🔒 lights off.

C. 🔄 Program mode indicator

● 🔄 Lights on, enter program display mode. Use ▲ or ▼ to view all values.

● 🔄 Flashes, enter program set mode. Press ▲ or ▼ to adjust values.







D. 🗄️ Menu/Confirm button

● Press 🗄️, 🔄 lights on, enter program display mode and use ▲ or ▼ to view all values.







● In program display mode, press 🗄️, 🔄 flashes, enter program set mode, press ▲ or ▼ and adjust values.

- Press  after all program are set, and then the voice “Di” means all setting are success and return program display mode.

E.  Manual/Return button



- Press  in any status, it can proceed to next step. (Example: Press  in Service status, it will start regeneration cycles instantly; Press  while it is in Backwash status, it will end backwash and go to Brine & Slow Rinse at once.)
- Press  in program display mode, and it will return in Service; Press  in program set mode, and it will return program display mode.
- Press  while adjusting the value, then it will return program display mode directly without saving value.





F. Down  and Up 

- In program display mode, press  or  to view all values.
- In program set mode, press  or  to adjust values.
- Press and hold both  and  for 5 seconds to lift the Button Lock status.

2.2. Basic Setting & Usage

A. Parameter specification (Take 63640B/63540B as example)

Function	Indicator	Factory Default	Parameter Set Range	Instruction
Time of Day		Random	00:00~23:59	Set the time of day when use; “: ” flashes.
Control Mode	A-01	A-01	A-01	Meter delayed: Regenerate on the day although the available volume of treated water drops to zero (0). Regeneration starts at the regeneration time.
			A-02	Meter immediate: Regenerate immediately when the available volume of treated water drops to zero (0).
Service		1-03D.	0~99 Days	Only for F112A1, F112B1, Time

Days				Clock Type, regeneration by days
Regeneration Time	02:00	02:00	00:00~23:59	Regeneration time; “:” lights on
Water Treatment Capacity		400.0	0~9999.9	Water treatment capacity in one circle (m ³)
Backwash Time		10:00	0~99:59	Backwash time(Minute:Second)
Brine Draw Time		60:00	0~99:59	Brine Draw Time (Minute:Second)
Slow Rinse Time	/	45:00	0~99:59	Slow Rinse Time (Minute:Second)
Fast Rinse Time		10:00	0~99:59	Fast rinse time(Minute:Second)
Brine Refill Time		05:00	0~99:59	Brine refill time(Minute:Second)
Maximum Interval Regeneration Days	H-30	30	0~40	Regenerate on the day even through the available volume of treated water does not drop to zero (0).
Output Control Mode	b-01	01	01 or 02	Mode b-01: Signal turn on start of regeneration and shut off end of regeneration. (Connection refer to the Figure P5)

				Mode b-02: Signal available only intervals of regeneration cycles and in service. (Connection refer to the Figure P5)
--	--	--	--	---

B. Process Display (Take 63640B A-01 as example)



Figure A



Figure B



Figure C

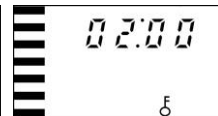

Figure D



Figure E



Figure F

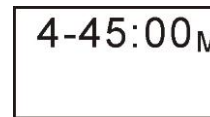

Figure G



Figure H



Figure J

Illustration:











1. In Service status, the figure shows A/B/C/D; In Backwash status, it shows Figure E/C; In Brine Draw status, it shows F/C; In Slow Rinse status, it shows G/C; In Fast Rinse status, it shows Figure H/C; In Brine Refill status, it shows Figure I/C. In each status, every figure shows 15 seconds.
2. Above displays are taking 63640B for example. For the Time Clock Type, it shows the rest days, such as 1-03D.
3. The display screen will only show “-00-” when the electrical motor is running.
4. The time of day figure flash continuously, such as “12: 12” flash, indicates long outage of power. It reminds to reset the time of day.
5. The display will show the error code, such as “-E1-” when the system is in error.













6. Working process: Service→ Backwash→ Brine Draw → Slow Rinse→ Fast Rinse→ Brine Refill →Service

C. Usage

After being accomplished installation, parameter setting and trial running, the valve could be put into use. In order to ensure the quality of outlet water can reach the requirement, the user should complete the below works:

- ① Ensure that there is solid salt all the time in the brine tank in the course of using when this valve is used for softening. The brine tank should be added the clean water softening salts only, at least 99.5% pure, forbidding use the fine salt and iodized salt.
- ② Test the outlet water and raw water hardness at regular time. When the outlet water hardness is unqualified, please press the  and the valve will temporary regenerate again(It will not affect the original set operation cycle)
- ③ When the feed water hardness changed a lot, you can adjust the water treatment capacity as follow:

Press and hold both  and  for 5 seconds to lift the lock status. Press , and the  lights on, then press , the digital area will show control mode A-01 or A-02. Press  three times to the digital area, it will show the given water treatment capacity. Press  again, the water treatment capacity value flash, then press  or  to reset the value to be requested. Press  twice and hear a sound “Di”, then finish the adjustment. Press  exit and turn back the service status.

- ④ For A-01 control mode (Delayed regeneration type), please pay attention to whether the time is current or not. If the time is not right, you can adjust as follow: After lifting the lock status, press , the  and “” light on. Then press , the  and hour value flash. Press  or  continuously, reset the hour value; Press  again,  and minute value flash. Press  or  continuously, reset the minute value; Press  and hear a sound “Di”, then finish the adjustment. Press  exit and turn back the service status.



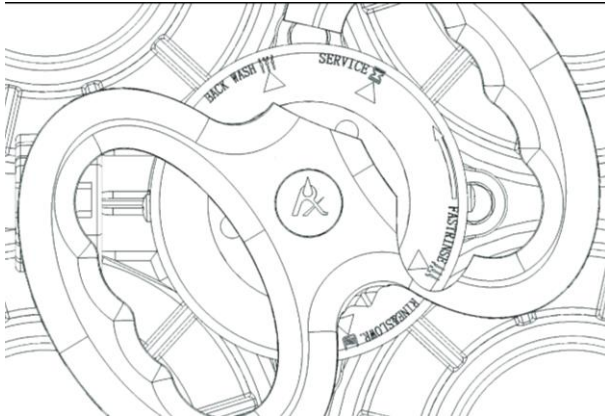

The regeneration parameters have been set when control valve left factory. Generally, it does not need to reset. If you want inquire and modify the setting, you can refer to the professional application specification.

2.3. Usage of Manual Wheel

During operation of this series control valve, rotate the manual wheel to make the pointer point to the relevant position and carry out Service, Backwash, Brine & Slow Rinse and Fast Rinse as below figure.



2.4. Meanings of Figures on Decorative Cover

English	Figures	Meanings
SERVICE		Service Status
BACK WASH		Backwash Status
BRINE & SLOW R.		Brine & Slow Rinse Status
BRINE REFILL		Brine Refill Status
FAST RINSE		Fast Rinse Status

3. Applications

3.1. Flow Chart

Down-flow/Up-flow regeneration softener valve (61240B/63540B/63640B) and filter valve (51240B/53540B/53640B) flow chart:

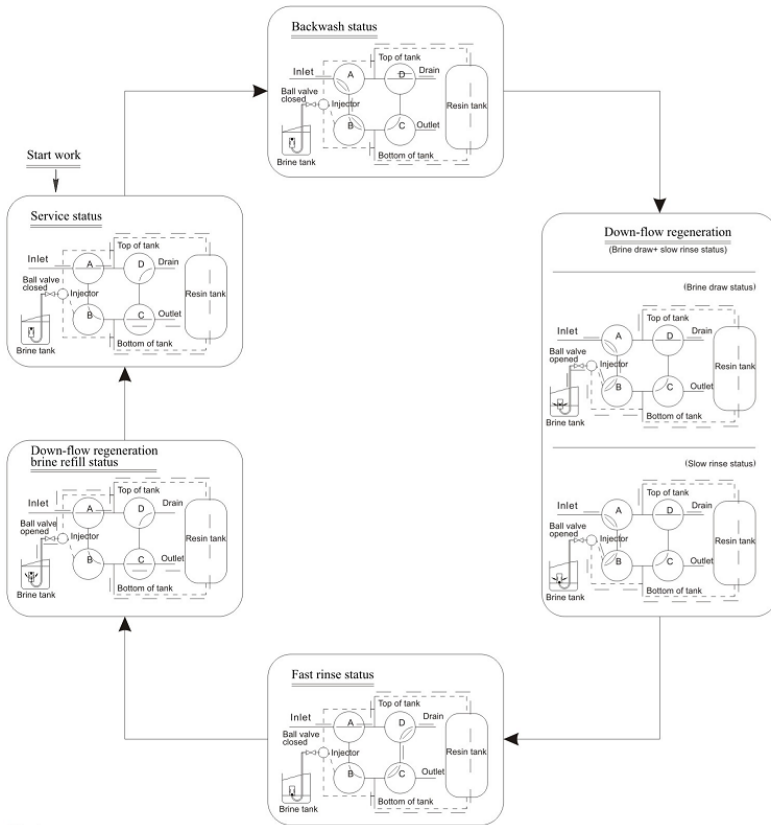

Note:

- For 51240B/53540B/53640B filter valve, only has service status, backwash status and fast rinse status.
- Brine refill is at the same time of service. When brine refill starts, the ball valve is opened, while it finished, the ball valve closes.
- Slow rinse is at the same time of brine draw. When brine draw finishes, the brine valve closed and slow rinse starts.

3.2. The Function and Connection of PC Board

Open the front cover of control valve, you will see the main control board and connection port as below:

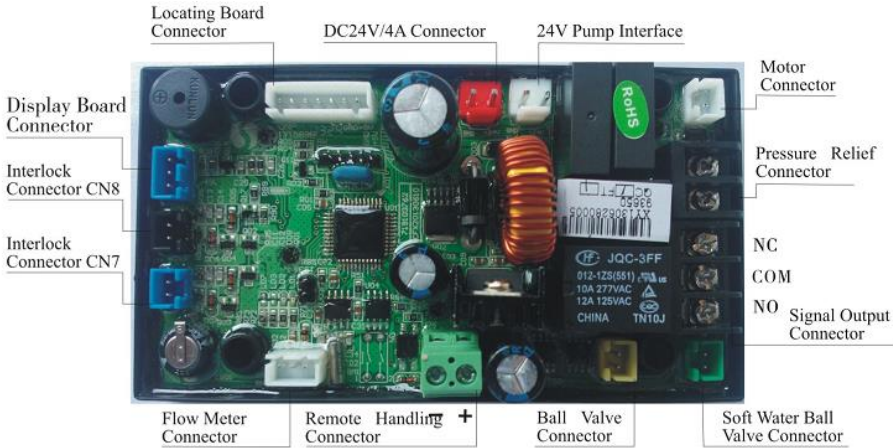

The main functions on main control board:

Function	Application	Explanation
Signal output connector b-01	Outlet solenoid valve	If system strictly require no hard water flow from outlet or controlling the liquid level in water tank.
	Inlet pump	Increase pressure for regeneration or washing. Use the liquid level controller to control inlet pump to ensure there is water in tank.
Signal output connector b-02	Inlet solenoid valve or inlet pump	When inlet pressure is high, it needs to close water inlet when valve is rotating to protect motor.
Pressure relief connector	Control the inlet bypass to release pressure	When valve is rotating, pressure relief connector opened to prevent pressure increasing rapidly.

Interlock connector	To ensure only one control valve regeneration or washing in system.	Use in RO Pre-treatment, water supply together but regeneration in turn. Second grade ion exchange equipment, etc.
Remote handling connector	Receipt signal to make the control rotate to next circle	It is used for on-line inspection system, PC connection, and realize automatically or remote controlling valve.

A. Signal Output Connector

1). Control Solenoid Valve (Set b-01)

① Solenoid valve on outlet controls water level in brine tank. Instruction: If system strictly require no hard water flow from outlet in regeneration cycle(Mainly for no hard water flow out when valve is switching or valve in backwash or brine drawing positions), a solenoid valve could be installed on outlet, the wiring refers to Figure 3-1.

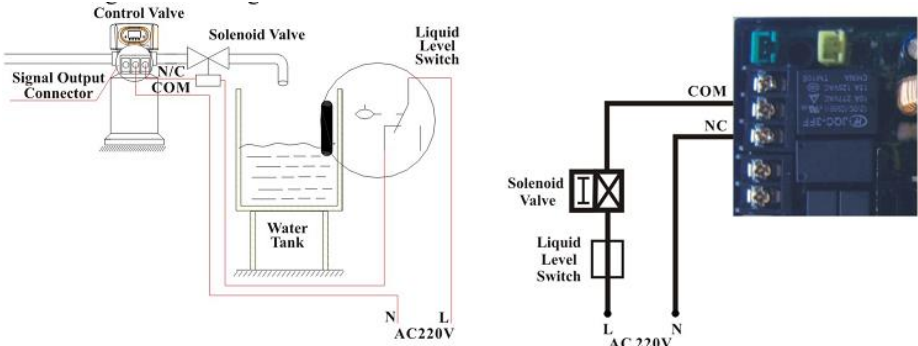

(Connect to Control Protection Case)
Figure3-1 Wring of Solenoid Valve on Outlet

Function:

When valve in service status, if soft water tank is short of water, solenoid valve is open to supply soft water, but if water tank has enough water, solenoid valve us closed, so no soft water supplied.

When the valve is in backwash status, there is no signal output. So, solenoid valve is closed, and no water flow into soft water tank.

② Solenoid Valve on Inlet(Set b-02)

Instruction: When inlet pressure exceeds 0.6MPa, install a solenoid valve on inlet. Control mode is b-02. Pressure relieved when valve switching, the wiring refer to Figure 3-2. As Figure 3-3 shows, it also can use the pressure relief port to work.

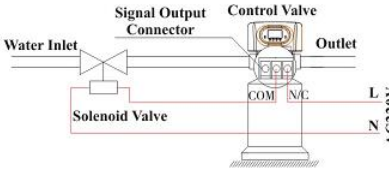

Figure 3-2 Wiring of Solenoid Valve on Inlet

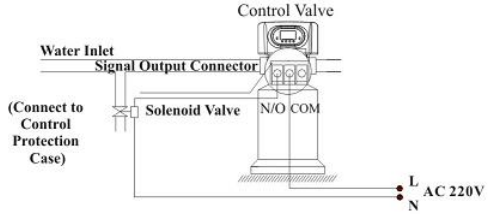

Figure3-3 Wiring of Pressure Relief Connector

Function:

When inlet pressure is high, install a solenoid valve on inlet to ensure valve switching properly. When valve is exactly at position of Service, Backwash, Brine& Slow Rinse, Brine Refill and Fast Rinse, solenoid valve is open. When valve is switching, solenoid valve is closed, no water flow into valve to ensure valve switching properly. It could prevent the problem from mix water and water hammer.

Use interlock cable to realize valves in parallel and series in same system which is suited for RO pretreatment system or second grade Na⁺ system. The wiring refers to Figure 3-4:

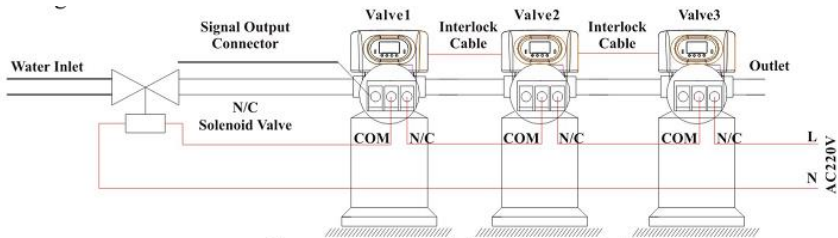

Figure 3-4 Wiring of Solenoid Valve in Inlet

2).Liquid Level Controller controls Inlet Pump (Two-phase motor) (Set b-01)

Instruction: For the system using well or middle-tank supplying water,

switch of liquid level controller and valve together control pump opening or closing. The wiring refers to Figure 3-5:

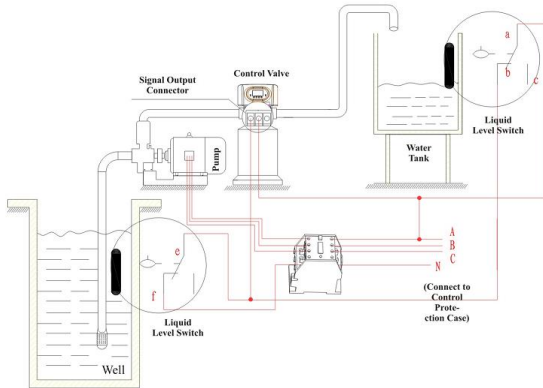

Figure3-6Wiring of Liquid Level Switch in Water Tank Controls Inlet Pump

Function:

When valve in service status, if water tank is short of water, start up pump, but if water tank has enough water, the switch of liquid level controller is closed, so pump doesn't work.

When valve in regeneration cycle, inlet always has water no matter what is water condition in water tank. As Runxin valve no water pass outlet in regeneration cycle, it ensure no water fill into brine tank.

A liquid switch at the top opening well or in middle water tank in RO system protect pump from working without water in case of out of raw water.

3). Liquid Level Switch in Water Tank Controls Inlet Pump (Three-phase) (Set b-01)

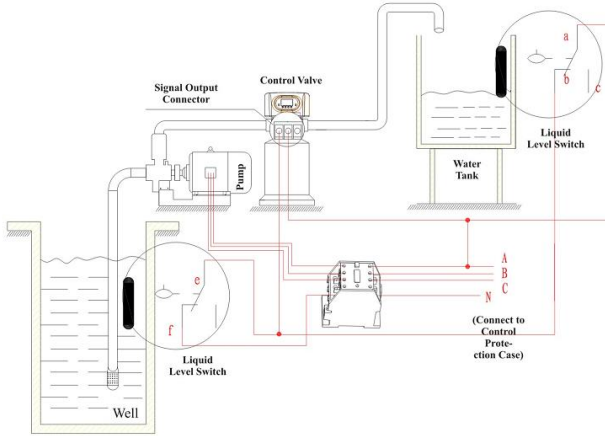

Figure3-6Wiring of Liquid Level Switch in Water Tank Controls Inlet Pump

4). Control Inlet Booster Pump (Set b-01 or b-02)

Instruction: If inlet water pressure is less than 0.15MPa, which makes rinse drawing difficult, a booster pump is suggested to be installed on inlet. Control mode b-01. When system in regeneration cycle, booster pump is open, the wiring refers to Figure 3-7.If the booster pump current is bigger than 5A, system need to install an contactor, the wiring refers to Figure3-8
 Figure 3-7Wiring of Booster Pump on Inlet Figure 3-8 Wiring of Booster Pump on Inlet

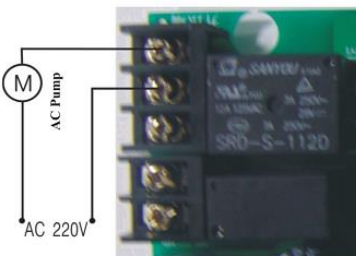

Figure 3-7Wiring of Booster Pump on Inlet

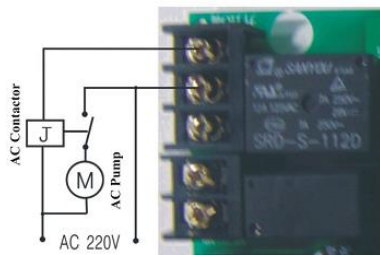

Figure 3-8 Wiring of Booster Pump on Inlet

B. Interlock

Instruction:

In the parallel water treatment system, it ensures only one valve in regeneration or washing cycle and (n-1) valves in service, that is, realizing the function of supplying water simultaneously and regenerating

individually.

In the series and parallel water treatment system (Second grade Na+ Exchanger or RO pre-treatment system), it ensures only one valve in regeneration or washing cycle and there is water in service. Refer to Figure 3-9

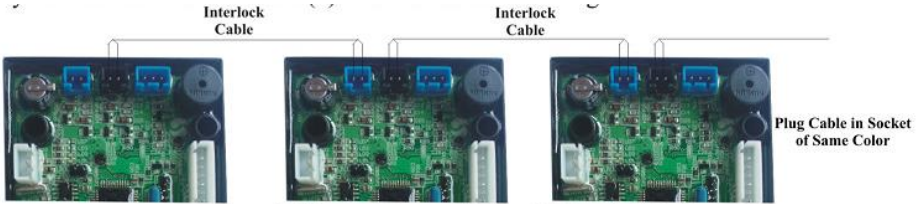

Figure 3-9 Network System Wiring with Interlock Cable

Note: Use Interlock Cable to connect CN8 to CN7 on next valve in the loop.

One system with several valves, if interlock cable is disconnected, the system is divided into two individual system.

C. Pressure Relief Output

Runxin valve will cut off feeding water to drain line when it switches in regeneration cycles. Thus in some water treatment system, e.g. Deep Well, one booster pump was installed on the inlet to increase the system water feeding pressure, this cut-off will cause pressure on inlet rising too fast to damage the valve. Pressure Relief Output can be used to avoid this problem. The wiring refers to Figure3-10.

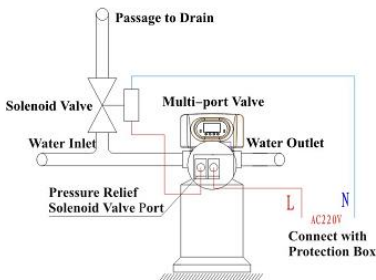

Figure 3-10 Wiring of Pressure Relief Output

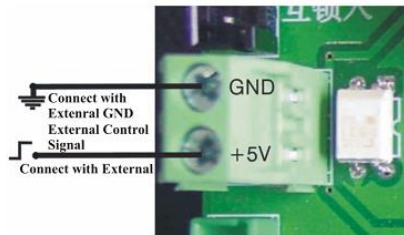

Figure3-11 Wiring of Remote Input

D. Remote Handling Connector

Used for making pure water, connected with online monitory system or PC machine: when the conductivity or other parameter reach the setting valve or PC machine give the signal, need regeneration. It can give the signal to the remote handling connector of the main control board to let it regenerate by signal time. The connector receives the signal is as same as handle press. The wiring refers to Figure 3-11.

E. Interlock system

At least 2 valves are interlocked connecting in one system and all valves are in service but regenerate individually. The wiring refers to Figure3-12.

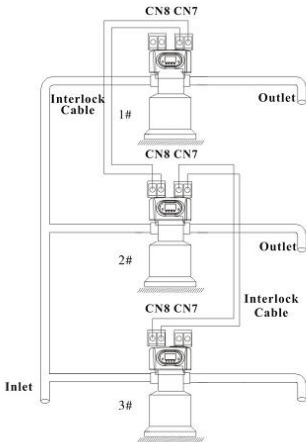

Figure 3-12 Interlock System

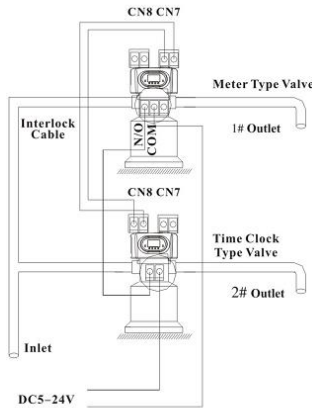

Figure 3-13 Series System

F. Series System

This is a 2 or more than 2 valves system, all in service, with one flow meter for the entire system. For the time type valve, the regeneration time should be set and adjusted to the Max; for the volume type valve, connect its signal output connector with the remote handle connector of the time-type valve. That can realize the function of supplying water simultaneously and regenerating orderly. The wiring refers to Figure 3-13:

3.3. System Configuration and Flow Rate Curve

A. Product Configuration

①61240B/63540B/63640B Fixed bed control valve configuration with tank, resin volume, brine tank and injector.

Tank Size (mm)	Resin Volume (L)	Flow Rate (t/h)	Brine Tank Size (mm)	The Minimum Salt Consumption for Regeneration (Kg)	Injector Model
φ1200×2400	2500	44.0	φ1240×1600	375.00	7803
φ1500×2400	3200	63.0	φ1360×1690	480.00	7804

Note: The flow rate calculation is based on linear velocity 25m/h; the minimum salt consumption for regeneration calculation is based on salt consumption 150g / L (Resin).

②51240B/53540B/53640B Filter control valve configuration with tank, filter material.

Tank Size	Volume of Filter Material	Carbon Filter		Sand Filter	
		Filtering Flow Rate	Backwash Flow Rate	Filtering Flow Rate	Backwash Flow Rate
mm	L	m ³ /h	m ³ /h	m ³ /h	m ³ /h
φ900×2400	900	7.6	22.9	15.9	34.3
φ1000×2400	1100	9.5	28.2	19.6	42.4
φ1200×2400	1500	13.5	40.7	28.2	61.0

Note: the filtering flow rate of carbon filter is calculated based on the 12m/h operation rate; the backwash flow rate is calculated based on the 10L/(m²*s) backwash intensity; the filtering flow rate of sand filter is calculated based on the 25m/h operation rate; the backwash flow rate is

calculated based on the 15L/(m²*s) backwash intensity.

B. Flow Rate Characteristic

1) Pressure-flow rate curve

Softener Valve: 61240B/63540B/63640B

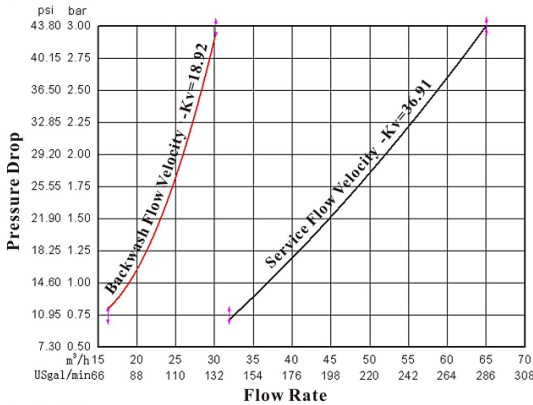

Filter Valve: 51240B/53540B/53640B

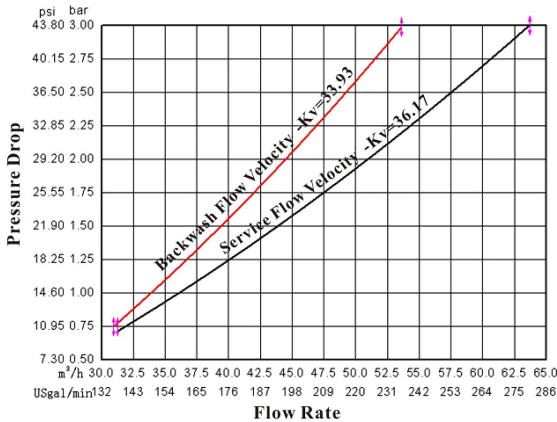

2) Configuration for standard injector and drain line flow control

Fixed bed 61240B/63540B/63640B

Tank	Injector	Injector	Draw Rate	Slow		Hole Qty	Backwash /
------	----------	----------	-----------	------	--	----------	------------

Dia. mm	Model	Color		Rinse	Brine Refill	on Drain Outlet	Fast Rinse
			L/h	L/h	L/h		t/h
1200	7803	Yellow	6800	4400	8640	2×φ7	17.32
1500	7804	Blue	8340	5400	8520	6×φ8	27.12

Note: ①The above data in table is tested under pressure of 0.3MPa.

②Since the different in the quality of raw inlet water, capacity of resin, size of the tank and the pressure of inlet, the above data are only for reference.

③If the real goods are different in specification, configuration or appearance, please subject to the real goods.

④The hole is made depending on the size of matched tank practical application. The hole's numbers and size are made based on the above table.

3.4. Parameter settlement

① Service time T1

Water treatment capacity:

$$Q = V_R \times K \div Y_D \quad (\text{m}^3)$$

Hardness of Inlet Water (mmol/L)

Exchange factor (mmol/L) 400~1000.

Down-flow regeneration, take 400 ~ 750. If the inlet water hardness is higher, the factor is smaller.

Resin volume (m³)

By days: $T1 = Q \div Q_d \quad (\text{Day})$

Water treatment capacity per day (m³/d)

Water treatment capacity (m³)

② Backwash time T2

It is subject to the turbidity of inlet water. Generally, it is suggested to be set 10~15 minutes. The higher the turbidity is, the longer backwash time can be set. However, if the turbidity is more than 5FTU, it had better to install a filter in front of the exchanger.

③ Brine & slow rinse time T3

$$T3 = (40 \sim 50) \times H_R \quad (\text{min.})$$

$$\text{Generally, } T3 = 45 H_R \quad (\text{min.})$$

In this formula, H_R — The height of resin in exchange tank (m.)

④ Brine refill time T4

$$\text{Down-flow regeneration: } T4 = 0.45 \times V_R \div \text{Brine refill speed} \quad (\text{min.})$$

In this formula, V_R — Resin volume (m³)

The Brine refill speed is related to inlet water pressure. It is suggested to lengthen 1~2 minutes of calculated brine refilling time to make sure there is enough water in tank. (The condition is that there is a level controller installed in the brine tank)

⑤ Fast rinse time T5

$$T5=12 \times H_R \text{ (min.)}$$

Generally, the water for fast rinse is 3~6 times of resin volume. It is suggested to be set 10~16 minutes, but subject to the outlet water reaching the requirement.

⑥ Exchange factor

$$\text{Exchange factor} = E / (k \times 1000)$$

In this formula, E—Resin working exchange capability (mol/m³), it is related to the quality of resin. Down-flow regeneration, take 800~900. Up-flow regeneration, take 900~1200.

K—Security factor, always take 1.2~2. It is related to the hardness of inlet water: the higher the hardness is, the bigger the K is.









⑦ Regeneration time:

The whole cycle for generation is about two hours. Please try to set up the regeneration time when you don't need water according to the actual situation.

The calculation of parameters for each step is only for reference, the actual proper time will be determined after adjusting by water exchanger supplier. This calculation procedure of softener is only for industrial application; it is not suitable for small softener in residential application.



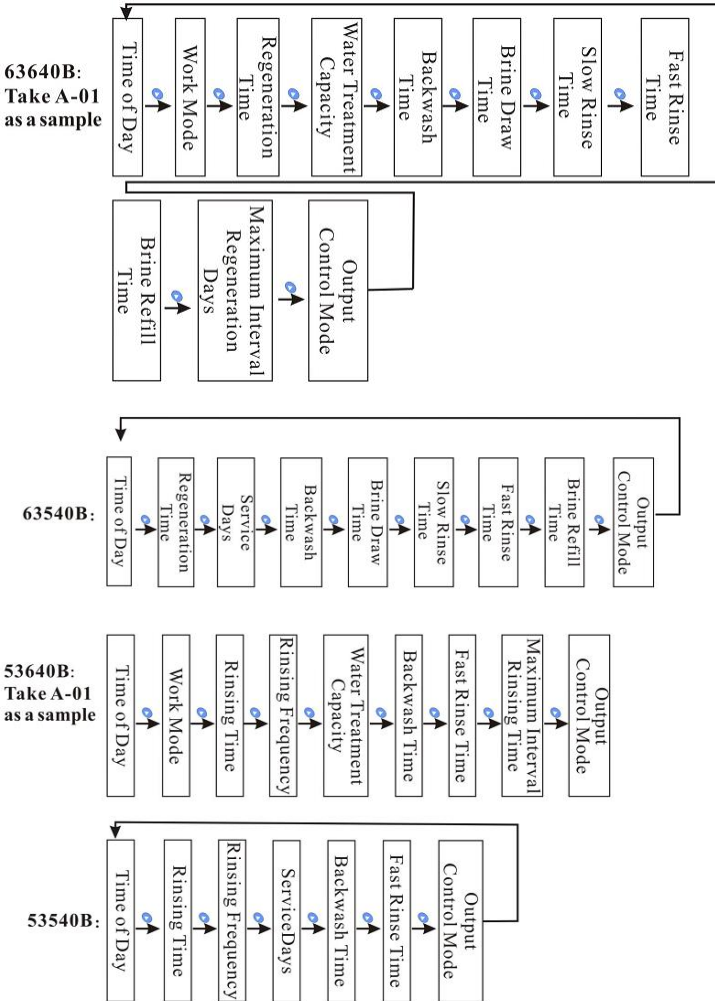

3.5. Parameter Inquiry and Setting

3.5.1. Parameter Inquiry



When  lights on, press and hold both  and  for 5 seconds to lift the button lock status; then press  and  lights on, enter to program display mode; press  or  to view each value according to below process. (Press  exit and turn back to service status)

































3.5.2. K valve setting method (It is related to flow rate factor. The K valve is opposite of the flow rate factor.)









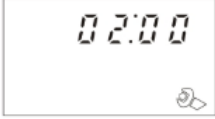































When powered on, press and hold on “” button and “” button for 3 seconds, enter into K valve setting interface. Press  and  button to adjust the valve. Press “” button to go back to working interface.























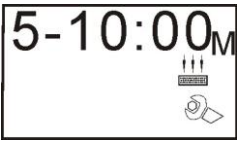







3.5.3. Parameter setting (Take 63640B A-01 as example)

In program display mode, press  and enter into program set mode. Press  or  to adjust the value.







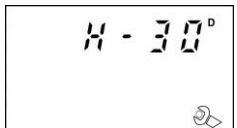





3.5.4. The Steps of Parameter Setting

Items	Process steps	Symbol
Time of Day	<p>When time of day “12:12” continuously flash, it reminds to reset;</p> <p>1. Press  to enter into program display mode; both  and “” symbol light on, “:” flash; Press , both  and hour value flash, through  or  to adjust the hour value;</p> <p>2. Press  again, both  and minute value flash, through  or  to adjust the minute value;</p> <p>3. Press  and hear a sound “Di”, then finish adjustment, press  to turn back.</p>	
Control Mode	<p>1. In control mode display status, press  and enter into program set mode,  and 01 value flash;</p> <p>2. Press  or , set the value to be A-01 or A-02 control mode;</p> <p>3. Press  and hear a sound “Di”, then finish adjustment, press  to turn back.</p>	
Regeneration Time	<p>1. In regeneration time display status, press  and enter into program set mode. It shows 02:00.  and 02 flash. Press  or  to adjust the hour value;</p> <p>2. Press ,  and 00 flash, press  or  to adjust the minute value;</p> <p>3. Press  and hear a sound “Di”, then finish adjustment, press  to turn back.</p>	

<p>Water Treatment Capacity</p>	<p>1. In water treatment capacity display status, it shows  and 400.0. Press  and enter into program set mode.  and 400 flash;</p> <p>2. Press  or  to adjust the water treatment capacity value (m³);</p> <p>3. Press , decimal value flashes. Press  or  to adjust the decimal value;</p> <p>4. Press  and hear a sound “Di”, then finish adjustment, press  to turn back.</p>	
<p>Back wash</p>	<p>1. In backwash time display status, it shows  and 2-10:00. Press  and enter into program set mode.  and 10 flash;</p> <p>2. Press  or  to adjust the backwash minute time ;</p> <p>3. Press , 00 flash. Press  or  to adjust the settling bed second value;</p> <p>4. Press  and hear a sound “Di”, then finish adjustment, press  to turn back.</p>	
<p>Brine Draw Time</p>	<p>1. In Brine Draw Time display status, it shows  and 3-60:00. Press  and enter into program set mode.  and 60 flash;</p> <p>2. Press  or  to adjust the brine draw minute time;</p> <p>3. Press , 00 flash. Press  or  to adjust the brine draw second value;</p> <p>4. Press  and hear a sound “Di”, then finish adjustment, press  to turn back.</p>	
<p>Slow Rinse Time</p>	<p>1. In Slow Rinse Time display status, it shows 4-45:00. Press  and enter into program set mode.  and 45 flash;</p> <p>2. Press  or  to adjust the slow rinse minute time;</p> <p>3. Press , 00 flash. Press  or  to adjust the slow</p>	

	<p>rinse second value;</p> <p>4. Press  and finish adjustment, press  to turn back.</p>	
<p>Fast Rinse Time</p>	<p>1. In fast rinse time display status, it shows  and 5-10:00. Press  and enter into program set mode.  and 10 flash;</p> <p>2. Press  or  to adjust the fast rinse minute time;</p> <p>3. Press , 00 flash. Press  or  to adjust the fast rinse second value;</p> <p>4. Press  and hear a sound “Di”, then finish adjustment, press  to turn back.</p>	
<p>Brine Refill Time</p>	<p>1. In brine refill time display status, it shows  and 6-05:00, Press  and enter into program set mode.  and 05 flash;</p> <p>2. Press  or  to adjust the brine refill minute time;</p> <p>3. Press , 00 flash. Press  or  to adjust the brine refill second value;</p> <p>4. Press  and hear a sound “Di”, then finish adjustment, press  to turn back.</p>	
<p>Maximum Interval Regeneration Days</p>	<p>1. In maximum Interval regeneration days display status, it shows H-30. Press  and enter into program set mode.  and 30 flash;</p> <p>2. Press  or  to adjust the Interval regeneration days;</p> <p>3. Press  and hear a sound “Di”, then finish adjustment, press  to turn back.</p>	

For example, the fast rinse time of a softener is 12 minutes. After regenerating, the chloridion in the outlet water is always higher than normal, indicating that there is no enough time for fast rinse. If you want the time to set to 15 minutes, the modification steps as follows:



- ① Press and hold both  and  to lift the button lock status (light off);
- ② Press , and  light on;
- ③ Press  or  continuously until  light on. Then the digital area shows: 5-12M;
- ④ Press ,  and 12 flash;
- ⑤ Press  continuously until 12 changed to 15;
- ⑥ Press , there is a sound “Di” and the figure stop flashing; the program back to inquiry status
- ⑦ If you want to adjust other parameters, you can repeat the steps from ② to ⑤; if you don't, press  and quit from the inquiry status, the display will show the current service status.



3.6. Trial Running

After installing the multi-functional flow control valve on the resin tank with the connected pipes, as well as setting up the relevant parameter, please conduct the trial running as follows:



A. Close the inlet valve B & C, and open the bypass valve A. After cleaning the foreign materials in the pipe, close the bypass valve A. (As Figure 1-2 shows)



B. Fill the brine tank with the planned amount of water and adjust the air check valve. Then add solid salt to the tank and dissolve the salt as much as possible.



C. Switch on power. Press  and go in the Backwash position; when  light on, slowly open the inlet valve B to 1/4 position, making the water flow into the resin tank; you can hear the sound of air-out from the drain pipeline. After all air is out of pipeline, then open inlet valve B completely and clean the foreign materials in the resin tank until the outlet water is clean. It will take 8~10 minutes to finish the whole process.

D. Press , turning the position from Backwash to Brine& Slow Rinse;  light on and enter in the process of Brine& Slow Rinse. The air check valve

close when control valve finished sucking brine, then slow rinse starts to work. It is about 60~65 minutes for whole process.

E. Press , turning the position from Slow Rinse to Fast Rinse.  lights on and start to fast rinse. After 10~15minutes, take out some outlet water for testing: If the water hardness reaches the requirement, and the chloridion in the water is almost the same, compared with the inlet water, then go to the next step.

F. Press  turning the position from Fast Rinse to Brine Refill.  lights on (Meanwhile it is in Service status) and it indicates the brine tank is being refilled with water to the required level. It takes about 5~6minutes, then add solid salt to the brine tank.

G. Press , making the control valve return to Service Status;  light on and start to running.

Note:

- When the control valve enters into the regeneration status, all program can be finished automatically according to the setting time; if you want one of steps terminated early, you can press .
- If water inflow too fast, the media in tank will be damaged. When water inflow slowly, there is a sound of air emptying from drain pipeline.
- After changing resin, please empty air in the resin according to the above Step C.
- In the process of trial running, please check the water situation in all position, ensuring there is no resin leakage.
- The time for Backwash, Brine Draw, Slow Rinse, Fast Rinse and Brine Refill position can be set and executed according to the calculation in the formula or suggestions from the control valve suppliers.

3.7. Trouble-Shooting

A. Control Valve Fault

Problem	Cause	Correction
1. Softener fails to regenerate.	A. Electrical service to unit has been interrupted. B. Regeneration cycles set incorrect. C. Controller is defective. D. Motor fails to work.	A. Assure permanent electrical service (Check fuse, plug, pull chain or switch). B. Reset regeneration cycles. C. Replace controller. D. Replace motor.
2. Regeneration time is not correct.	A. Time of Day doesn't set correctly. B. Power failure more than 3 days.	Check program and reset time of day.
3. Softener supply hard water.	A. Bypass valve is open or leaking. B. No salt in brine tank. C. Injector plugged. D. Insufficient water flowing into brine tank. E. Internal valve leak. F. Regeneration cycles not correct. G. Shortage of resin. H. Raw water quality turns bad or flow meter blocked.	A. Close or repair bypass valve. B. Add salt to brine tank and maintain salt level above water level. C. Change or clean injector. D. Check brine tank refill time. E. Change valve body. F. Set correct regeneration cycles in the program. G. Add resin to mineral tank and check whether resin leaks. H. Reduce the raw water turbidity or clean or replace the flow meter.

<p>4. Softener fails to draw brine.</p>	<p>A. Line pressure is too low. B. Brine line is plugged. C. Brine line is leaking. D. Injector is plugged. E. Internal control leak. F. Drain line is plugged. G. Sizes of injector and DLFC not match with tank. H. Ball valve or cable failure.</p>	<p>A. Increase line pressure. B. Clean brine line. C. Replace brine line. D. Clean or replace new parts. E. Replace valve body. F. Clean drain line flow control. G. Select correct injector size and DLFC according to the P20 requirements. H. Replace ball valve or cable.</p>
<p>5. Unit used too much salt.</p>	<p>A. Improper salt setting. B. Excessive water in brine tank.</p>	<p>A. Check salt usage and salt setting. B. See problem no.6.</p>
<p>6. Excessive water in brine tank.</p>	<p>A. Overlong refilling time. B. Foreign material in brine line. C. Foreign material in brine valve and plug drain line flow control. D. Not install safety brine valve but power failure while salting. E. Safety brine valve breakdown. F. Ball valve doesn't close completely.</p>	<p>A. Reset correct refilling time. B. Clean brine line. C. Clean brine valve and brine line. D. Stop water supplying and restart pr install safety brine valve in salt tank. E. Repair or replace safety brine valve. F. Repair or replace ball valve.</p>
<p>7. Pressure lost or iron in conditioned water.</p>	<p>A. Iron in the water supply pipe. B. Iron mass in the softener. C. Fouled resin bed. D. Too much iron in the</p>	<p>A. Clean the water supply pipe. B. Clean valve and add resin cleaning chemical, increase frequency of regeneration. C. Check backwash, brine draw and brine tank refill. Increase</p>

	raw water.	frequency of regeneration and backwash time. D. Iron removal equipment is required to install before softening.
8. Loss of mineral through drain line.	A. Air in water system. B. Bottom strainer broken. C. Improperly sized drain line control.	A. Assure that well system has proper air eliminator control. B. Replace new bottom strainer. C. Check for proper drain rate.
9. Control cycle continuously.	A. Locating signal writing breakdown. B. Controller is faulty. C. Foreign material stuck the driving gear. D. Time of regeneration steps were set to zero.	A. Check and connect locating signal wiring. B. Replace controller. C. Take out foreign material. D. Check program setting and reset.
10. Drain flows continuously.	A. Internal valve leak. B. When electricity fails to supply, valve stops backwash or fast rinse position.	A. Check and repair valve body or replace it. B. Adjust valve to service position or turn off bypass valve and restart when electricity supply.
11. Interrupted or irregular brine.	A. Water pressure too low or not stable. B. Injector is plugged or faulty. C. Air in resin tank. D. Floccules in resin tank during backwash. E. Strainer is plugged.	A. Increase water pressure. B. Clean or replace injector. C. Check and find the reason. D. Clean the floccules in resin tank. E. Clean the broken resin from strainer.
12. Water flow out from drain or brine pipe	A. Foreign material in valve which makes valve can't be closed completely.	A. Clean foreign material in valve body. B. Change valve core or sealing

<p>after regeneration.</p>	<p>B. Hard water mixed in valve body. C. Water pressure is too high which result in valve doesn't get the right position. D. Ball valve is not being closed completely.</p>	<p>ring. C. Reduce water pressure or use pressure release function. D. Repair or replace the ball vale or the wire.</p>
<p>13. Salt water in soften water.</p>	<p>A. Foreign material in injector pr injector fails to work. B. Brine valve cannot be shut-off. C. Time of rapid rinse too short.</p>	<p>A. Clean and repair injector. B. Repair brine valve and clean it. C. Extend rapid rinse time.</p>
<p>14. Unit capacity decreases.</p>	<p>A. Unit fails to regenerate or regenerate not properly. B. Fouled resin bed. C. Salt setting not proper. D. Softener setting not proper. E. Raw water quality deterioration. F. Turbine of flow meter is stuck.</p>	<p>A. Regenerate according to the correct operation requirement. B. Increase backwash flow rate and time, clean or change resin. C. Readjust brine drawing time. D. According to the test of outlet water, recount and reset. E. Regenerate unit by manual temporary, then reset regeneration cycle. F. Disassemble flow meter and clean it or replace a new turbine.</p>

B. Controller Fault

Problem	Cause	Correction
---------	-------	------------

<p>1. All indicators display on front panel.</p>	<p>A. Wiring of front panel with controller fails to work. B. Control board is faulty. C. Transformer damaged. D. Electrical service not stable. E. Display board is damaged.</p>	<p>A. Check and replace the wiring. B. Replace control board. C. Check and replace transformer. D. Check and adjust electrical service. E. Replace the display board.</p>
<p>2. No display on front panel.</p>	<p>A. Wiring of front panel with controller fails to work. B. Front panel damaged. C. Control board damaged. D. Electricity is interrupted.</p>	<p>A. Check and replace wiring. B. Replace front panel. C. Replace control board. D. Check electricity.</p>
<p>3. E1 Flashes</p>	<p>A. Wiring of locating board with controller fails to work. B. Locating board damaged. C. Mechanical driven failure. D. Faulty control board. E. Wiring of motor with controller is fault. F. Motor damaged.</p>	<p>A. Replace wiring. B. Replace locating board. C. Check and repair mechanical part. D. Replace control board. E. Replace wiring. F. Replace motor.</p>
<p>4. E2 Flashes</p>	<p>A. Hall component on locating board damaged. B. Wiring of locating board with controller fails to work. C. Control board is faulty.</p>	<p>A. Replace locating board. B. Replace wiring. C. Replace control board.</p>
<p>5. E3 or E4 Flashes</p>	<p>A. Control board is faulty.</p>	<p>A. Replace control board.</p>

3.8. Assembly & Parts

63640B Structure (Main body part)

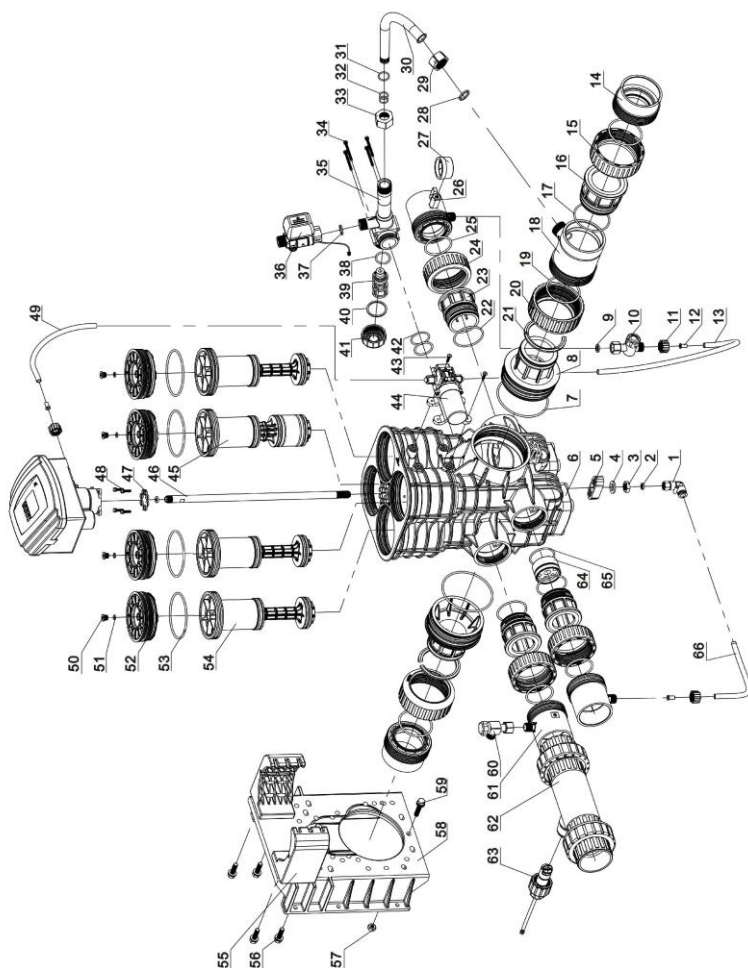

63640B Valve Body Components and Part No.

Item no.	Description	Part No.	Quantity	Item No.	Description	Part No.	Quantity
1	Air Pipeline Connector	5455001	1	34	Hexagonal Bolt Set	5851005	4
2	Seal Washer	8371011	2	35	Injector Body	8008005	1

3	Nut	8940005	1
4	Washer	8952003	1
5	Gasket	8156003	1
6	Valve Body	5022088	1
7	O-ring	8378214	2
8	Connector	8458104	2
9	Seal Washer	8371021	1
10	Filter Valve	3914001	1
11	Hexagonal Nut	8940016	3
12	Pipeline	8457025	3
13	Air Pipeline	8465018	3
14	Connector	8458024	2
15	Animated Nut	8947008	1
16	Connector	8458022	1
17	O-ring	8378129	1
18	Injector Connector	8458023	4
19	O-ring	8378138	3
20	Animated Nut	8947036	2
21	Clip	8270017	1
22	O-ring	8378127	3
23	Connector	8458020	3
24	Animated Nut	8947007	3
25	O-ring	8378137	3
26	Pressure Gauge Protect Valve	2976013	1
27	Pressure Gauge	6342001	1
28	Washer	8371001	1
29	Nut	8940006	1
30	Elbow Pipeline	8457103	1
31	O-ring	8378113	1
32	O-ring	8378162	1

36	Ball Valve	6922075	1
37	Seal Washer	8371019	1
38	O-ring	8378104	1
39	Nozzle	8454024	1
40	Seal Washer	8371006	1
41	Injector Cover	8315013	1
42	O-ring	8378101	2
43	Screw, Cross	8909019	2
44	Diaphragm Pump	2976091	1
45	Piston	5450004	1
46	Pipeline	8457075	1
47	Seal Washer	8371009	8
48	Hexagonal Bolt Set	5851006	4
49	Air Pipeline	8465017	1
50	Plug	8232016	4
51	O-ring	8378031	4
52	Cover	8315064	4
53	O-ring	8378263	4
54	Piston	5450003	3
55	Foil	5156004	2
56	Hexagonal Bolt Set	5851001	4
57	Hexagonal Nut	8940023	1
58	Fixed	8109053	1
59	Hexagonal Bolt Set	5851009	1
60	Corner Valve	3911004.05	1
61	Connector	8458021	4
62	Tee Joint	5457009	1
63	Impeller	5295004	1
64	Flow Control	8468047	1
65	O-ring	8378125	1

33	Nut	8940007	1	66	Air Pipeline	8465019	1
----	-----	---------	---	----	--------------	---------	---

Note:

- For 63540B components, there is no #62 and #63 compared to 63640B.
 - For 53640B components, there is no #15~#18, and change #28~#41 to 1 piece of 8323012 compared to 63640B.
 - For 53540B components, there is no #62 and #63 compared to 53640B.
- 63640B Distribution valve

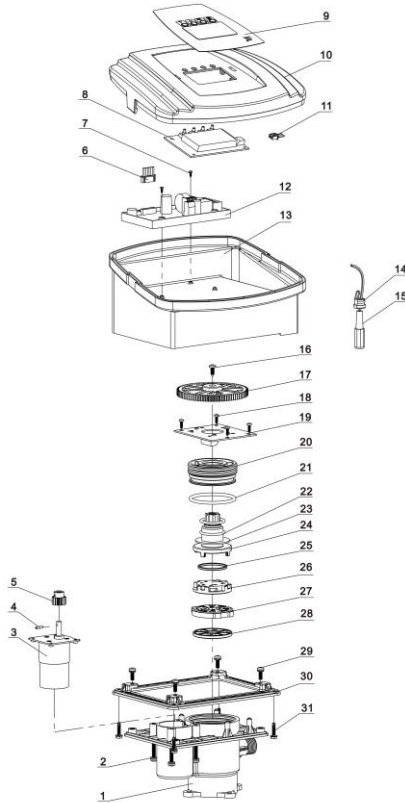

63640B Distribution Valve Components and Part No.

Item No.	Description	Part No.	Quantity	Item No.	Description	Part No.	Quantity
1	Valve Body	5022028	1	17	Gear	5241005	1
2	Screw, Cross	8902008	4	18	Screw, Cross	8909008	4
3	Motor	6158007	1	19	Locating Board	6380041	1
4	Pin	8993001	1	20	Fitting Nut	8092007	1
5	Small Gear	8241010	1	21	O-ring	8378107	1
6	Wire for Locating Board	5511019	1	22	O-ring	8378078	2
7	Screw, Cross	8909004	2	23	Anti-friction Washer	8216010	1
8	Display Board	6381003	1	24	Shaft	8258009	1
9	Label	8865001	1	25	Seal Ring	8370053	1
10	Front Cover	8300002.05	1	26	Moving Disk	8459025	1
11	Wire for Display Board	5512001	1	27	Fixed Disk	8469023	1
12	Control Board	6382057	1	28	Seal Ring	8370031	1
13	Back Cover	8005002	4	29	Screw, Cross	8902005	4
14	Wire Clip	8126007	1	30	Connecting Board	8152033	1
15	Power Wire	5513011	1	31	Screw, Cross	8909016	4
16	Screw, Cross	8909013	1				

61240B Structure (Main body part) :

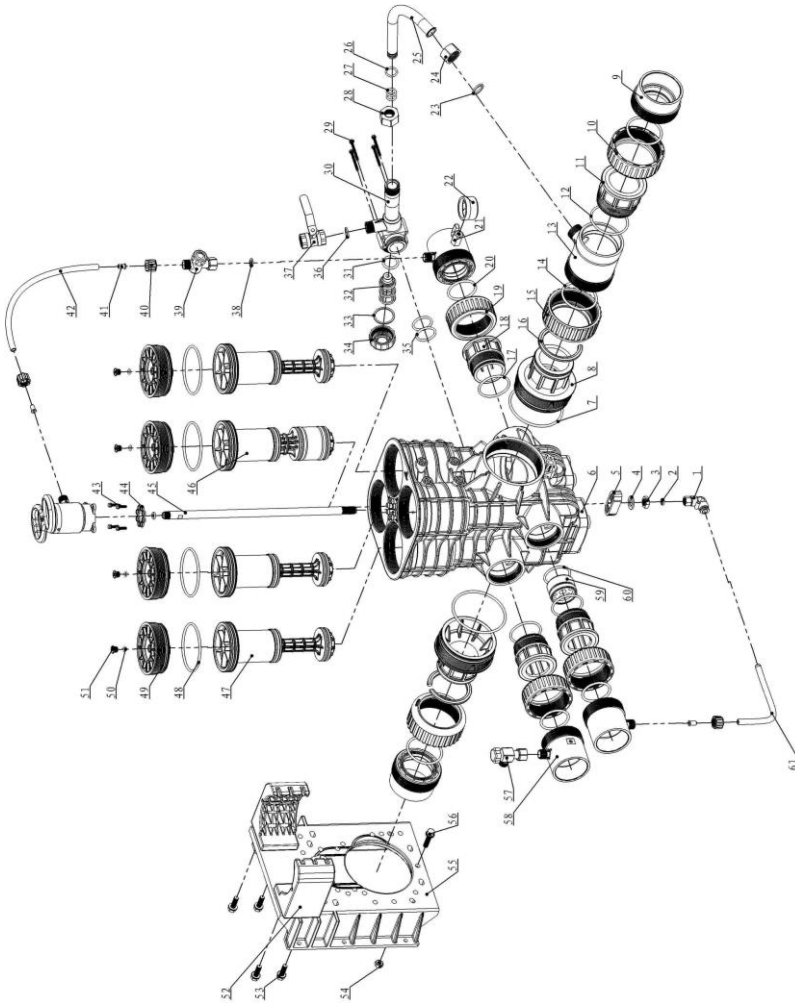

61240B Valve Body Components and Part No.

Item no.	Description	Part No.	Quantity	Item no.	Description	Part No.	Quantity
1	Air Pipeline Connector	5455001	1	32	Nozzle	8454024	1
2	Seal Washer	8371011	2	33	Seal Washer	8371006	1
3	Nut	8940005	1	34	Injector Cover	8315013	1

4	Washer	8952003	1
5	Gasket	8156003	1
6	Valve Body	5022088	1
7	O-ring	8378214	2
8	Connector	8458104	2
9	Connector	8458024	2
10	Animated Nut	8947008	1
11	Connector	8458022	1
12	O-ring	8378129	1
13	Injector Connector	8458023	1
14	O-ring	8378138	3
15	Animated Nut	8947036	2
16	Clip	8270017	1
17	O-ring	8378127	3
18	Connector	8458020	3
19	Animated Nut	8947007	3
20	O-ring	8378137	3
21	Pressure Gauge Protect Valve	2976013	1
22	Pressure Gauge	6342001	1
23	Washer	8371001	1
24	Nut	8940006	1
25	Elbow Pipeline	8457103	1

35	O-ring	8378101	2
36	Seal Washer	8371019	1
37	Electric Ball valve	2978052	1
38	Seal Washer	8371021	1
39	Filter Valve	3914001	1
40	Hexagonal Nut	8940016	3
41	Pipeline	8457025	3
42	Air Pipeline	8465017	1
43	Hexagonal Bolt Set	5851006	4
44	Seal Washer	8371009	8
45	Pipeline	8457075	1
46	Piston	5450004	1
47	Piston	5450003	3
48	O-ring	8378263	4
49	Cover	8315064	4
50	O-ring	8378031	4
51	Plug	8232016	4
52	Foil	5156004	2
53	Hexagonal Bolt Set	5851001	4
54	Hexagonal Nut	8940023	1
55	Fixed	8109053	1
56	Hexagonal Bolt Set	5851009	1

26	O-ring	8378113	1
27	O-ring	8378162	1
28	Nut	8940007	1
29	Hexagonal Bolt Set	5851005	4
30	Injector Body	8008005	1
31	O-ring	8378104	1

57	Corner Valve	3911004.05	1
58	Connector	8458021	4
59	Flow Control	8468047	1
60	O-ring	8378125	1
61	Air Pipeline	8465019	1

Note:

- For 51240B components, there is no #10~#13, and change #23~#37 of 61240B to 1 piece of 8323012.

61240B Distribution valve

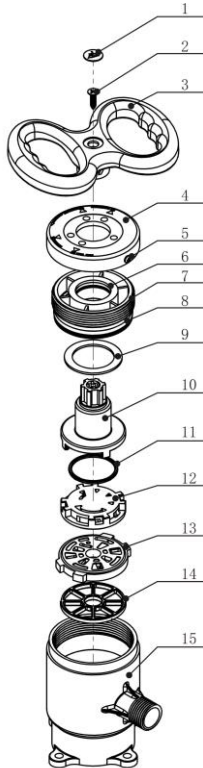

61240B Distribution Valve Components and Part No.

Item No	Description	Part No.	Quantity
1	Label	8860001	1
2	Screw, Cross	8909014	1
3	Manual Wheel	8253033	1
4	Cover	8444018	1
5	Screw, Cross	8909008	1
6	O-ring	8378078	1
7	Fitting Nut	8092007	1
8	O-ring	8378107	1
9	Anti-friction Washer	8216010	1
10	Shaft	8258009	1
11	Seal Ring	8370053	1
12	Moving Disk	8459025	1
13	Fixed Disk	8469023	1
14	Seal Ring	8370031	1
15	Distribution Valve Body	8022060	1

Note:

For 51240B (Distribution Valve) components, change #4 of 61240B (Distribution Valve) to 8444019.

5450003 Piston structure

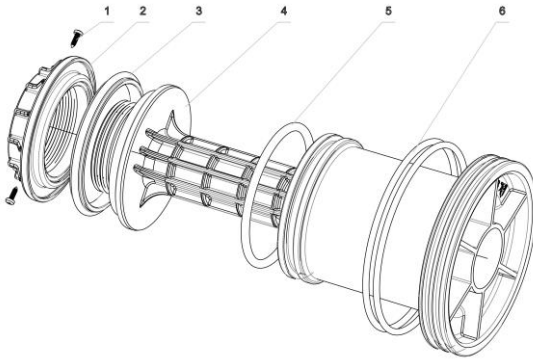

5450003 Piston Components and Part No.

Item No.	Description	Part No.	Quantity	Item No.	Description	Part No.	Quantity
1	Screw, Cross	8909008	2	4	Piston	8450006	1
2	Fitting Nut	8092047	1	5	O-ring	8378262	1
3	Seal Ring	8370102	1	6	O-ring	8378263	2

5450004 Piston structure

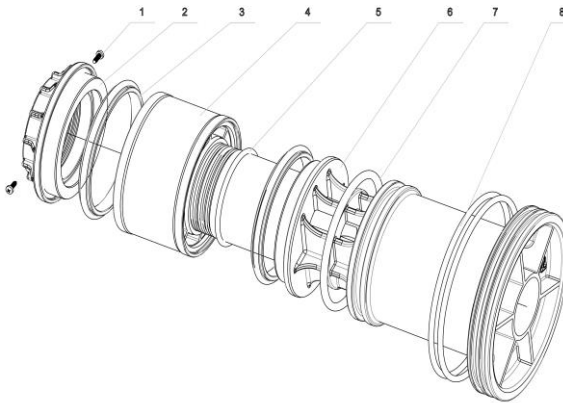

5450004 Piston Components and Part No.

Item No.	Description	Part No.	Quantity	Item No.	Description	Part No.	Quantity
1	Screw, Cross	8909008	3	5	O-ring	8378184	1
2	Fitting Nut	8092048	1	3	Piston	8450007	1
3	Seal Ring	8370102	2	7	O-ring	8378262	1
4	Bushing	8210006	1	8	O-ring	8378263	1

5040009 Support structure

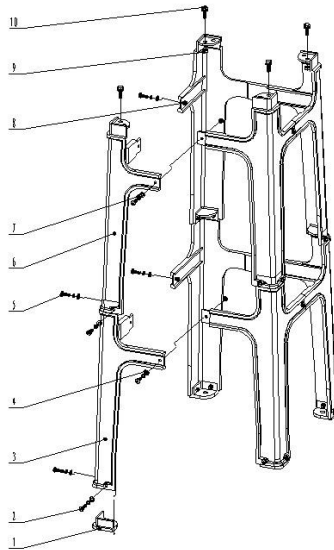

5040009 Support components and part No.

Item No.	Description	Part No.	Quantity	Item No.	Description	Part No.	Quantity
1	Door Mat	8156002	4	6	Support	8040031	4
2	Screw, Cross M6X25	8902039	8	7	Spring Washer	8953001	24
3	Support	8040030	4	8	Hexagonal Nut	8940020	24
4	Washer	8952007	24	9	Hexagonal Nut	8940021	4
5	Screw, Cross M6X20	8902038	16	10	Hexagonal Bolt Set	5851002	4

4. Guarantee Card

Dear client:

This warranty card is the guarantee proof of RUNXIN brand multi-functional flow control valve. It is kept by client self. You could get the after-sales services from the supplier which is appointed by RUNXIN manufacturer. Please keep it properly. It couldn't be retrieved if lost.

It couldn't be repaired free of charge under the below conditions:

1. Guarantee period expired. (One year)
2. Damage resulting from using, maintenance, and keeping that are not in accordance with the instruction.
3. Damage resulting from repairing not by the appointed maintenance personnel.
4. Content in guarantee proof is unconfirmed with the label on the real good or be altered.
5. Damage resulting from force majeure.

Product Name	 润新 RUNXIN	Multi-functional Flow Control Valve for Water Treatment Systems			
Model		Code of Valve Body			
Purchase Company Name		Tel/Cel.			
Problem					
Solution					
Date of Repairing		Date of Accomplishment		Maintenance Man Signature	

When control valve need to send back for repair, please fill in the below content and sent this card together with the product to the appointed suppliers or Runxin company.

End-user Company Name		Tel/Cel.	
Purchase Company Name		Tel/Cel.	
Model		Code of Valve Body	
Tank Size ϕ ×	Resin Tank Size L	Raw Water Hardness mmol/L	
Water Source: Ground-water <input type="checkbox"/> Tap Water <input type="checkbox"/>	Water Treatment Capacity m3	Backwash Time min	
Brine & Slow Rinse Time min	Brine Refill Time min	Fast Rinse Time min	
Problem Description			

WENZHOU RUNXIN MANUFACTURING MACHINE CO., LTD.

ADD : Jinger Road, Shatou Group, Linjiang, Lucheng District,
Wenzhou, Zhejiang, China

TEL: 0577-88635628 88630038 FAX: 0577-88633258

<http://www.run-xin.com> Email:sales@run-xin.com